

AC/DC converter



Micro SMPS

www.easypower.in

AC/ DC converter

Features



- **Universal Input : 110- 260 VAC**
- **Operating Temperature Range : 0°C - +50°C**
- **High isolation voltage up to 1kV**
- **Regulated output, low ripple and noise**
- **High efficiency, high reliability**

SO12V1000 Micro SMPS – a compact size power converter offered by *EASY POWER*. It features universal input voltage, taking AC/DC voltage, low power consumption, high reliability, and safer isolation.

Input Specification					
Item	Operating condition	Min.	Typ.	Max.	Unit
Input Voltage Range	AC input	110		260	VAC
Input Voltage Range	DC input	150		300	VDC
Input frequency		50		50	Hz
Leakage current		0.1 mA RMS typ. 230 VAC/50 Hz			
Recommended external input fuse		1A/ 250V, slow fusing, necessary.			

Output Specification					
Item	Operating conditions	Min.	Typ.	Max	Unit
Output voltage accuracy	12V output	-	±0.2	-	%
Line regulation	Full load	-	±0.5	-	
Load regulation	0% - 100% load	-	±1	-	
Ripple & Noise	20 MHz bandwidth (Pk – Pk) value	-	50	100	mV
Output current		-	900	1000	mA
Temperature drift coefficient		-	±0.02	-	%/°C
Min Load		0	-	0	%
Isolation voltage – Input voltage	Test time: 1min	1000	-	-	VAC
Operating Temperature		0	-	+50	°C
Storage Temperature		0	-	+60	°C
Storage Humidity		-	-	90	%RH
Welding Temperature	Wave soldering	260 ± 5°C; time 5 – 10s			
	Manual welding	360 ± 10 °C; time 3 – 5s			
Switching frequency		-	100	-	kHz

AC/DC converter



Micro SMPS

Physical Specification	
Casing Material	Black colour, heat resistant
Packaging Dimension	37.02 x 34 x 24.00
Weight	45 gm (Typ.)
Cooling method	Free air convection

Design reference

Typical Application Diagram -

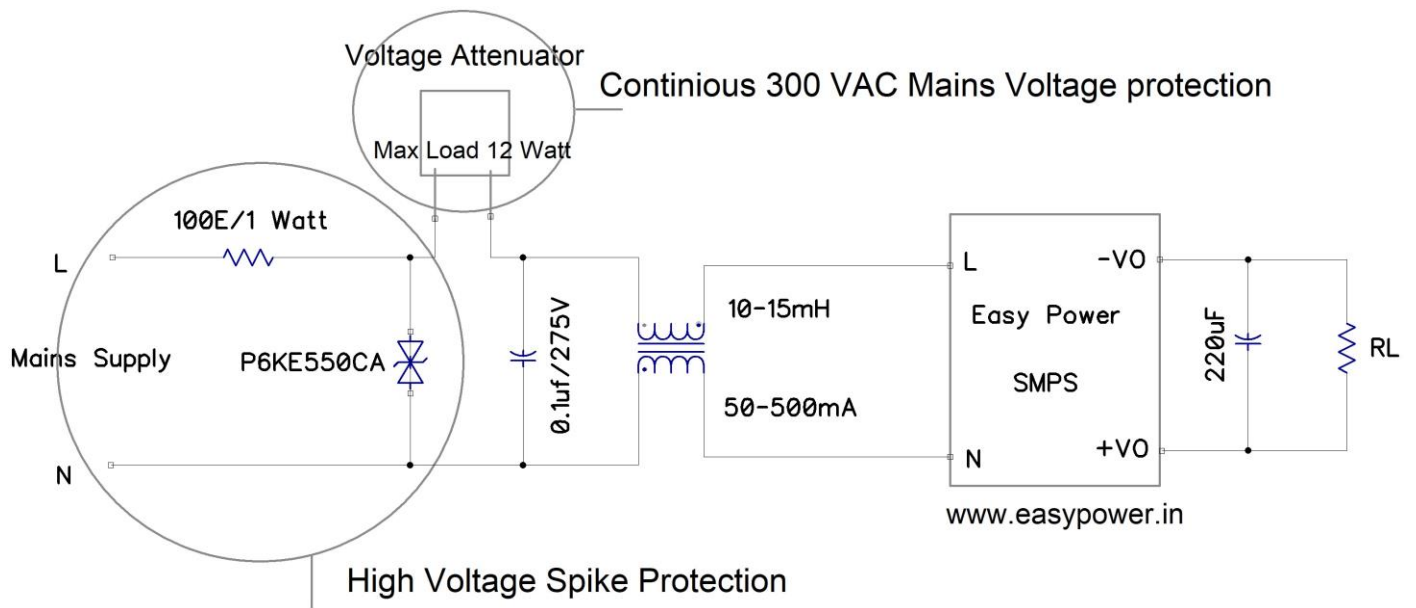

Component number/ Recommended device	Function	Value
Fuse	Protect the circuit from damage when the module is abnormal.	100E/1Watt
TVS Diode	Protect the module do not damaged in the accumulative surge	P6KE550CA
C1/Safety capacitor	Filtering safety protection (EMC certification)	0.1uF/275Vac
L1/Common mode choke	EMI filtering	Sense value 10-15mH, current 70-500mA

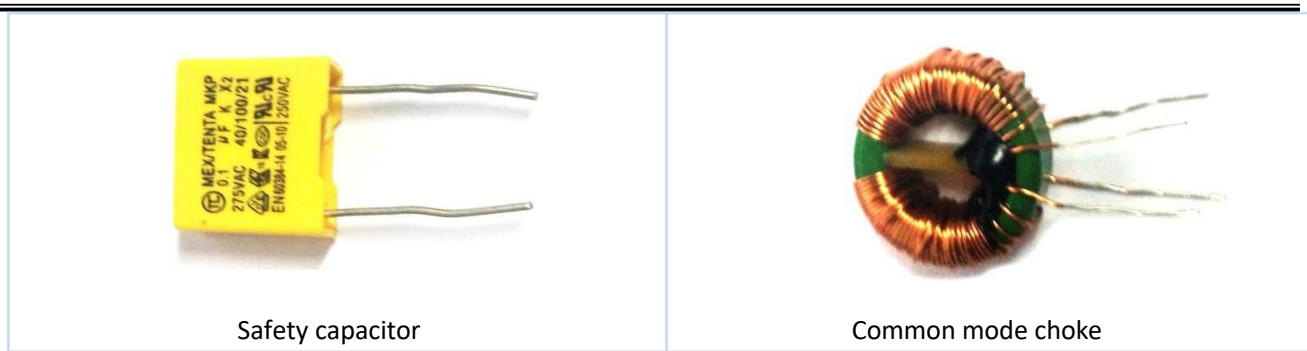

Output section

Component number/ Recommended device	Function	Value
C2/ Filtering capacitor	Filtering the output AC signal can be maintain within 30mV	Aluminum electrolytic capacitors, capacitance range 100-220uF, Pressure drop>75%
RL/ Load	Load	

Note : C2 filtering capacitor can bring down the output signal from the original 50mV to less than 30mV.

AC/DC converter

Micro SMPS

Footprint:

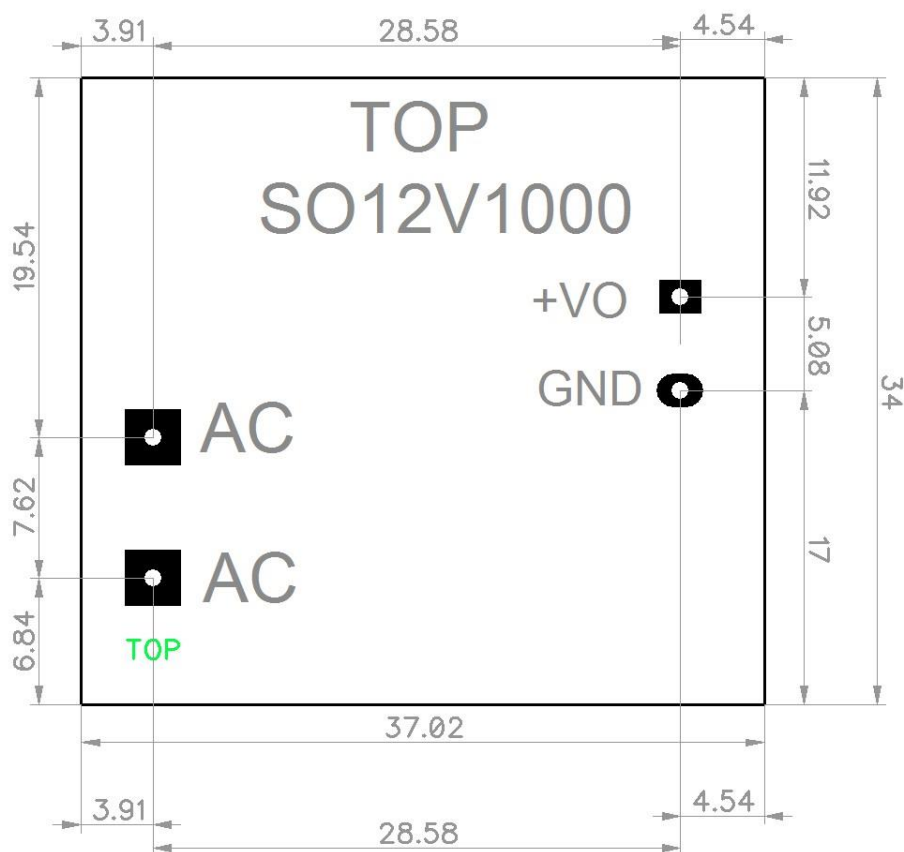

All dimensions are in **millimetre**.

Product height is of 24 mm

Product width is of 34 mm

Product length is of 37.02 mm